



GARDICO®

FOR LANDSCAPING

Gardeco was founded in the year of 2000. It is a private trade company. It is based in Cracow. The founder of the company is Joanna Dobroń. The basic activity of the company is the export of carefully selected products of the best Polish manufacturers. Gardeco provides services only B2B. European trade networks and wholesalers make the majority of Gardeco clients. Thanks to the experience achieved and very good logistics, Gardeco products are available in stationary and Internet stores in whole Europe (Germany, Austria, France, Finland, Sweden, Norway, Denmark, Slovakia, Czech Republic, Lithuania, Latvia, Estonia, Spain, Netherlands and many more). We encourage you to look into our company's wide offer. We are proud to offer high-quality products for house, garden, workshop and landscaping. The goal of the company is thorough and professional customer service by not only providing the best products at competitive prices, but also through consulting, passing on our knowledge, offering the best solutions, partnership and fruitful, long-lasting cooperation.

## Contact Us:

### **Weronika Glanowska**

Export Manager

mail: [verkauf@gardeco.com.pl](mailto:verkauf@gardeco.com.pl)

mobile: +48 667 041 667

### **Lidia Sawicka**

Customer Service Manager

mail: [ls@gardeco.com.pl](mailto:ls@gardeco.com.pl)

mobile: +48 665 914 665

# LAWN GRID PLATE



## THE OFFER INCLUDES 30 MM AND 38 MM THICKNESSES

---

Our products meet the requirements  
in accordance with  
PN-EN 124 and PN - EN1433.

Product in load class A15 and B125

# Lawn Grid Plate 30 mm

Available colours: ● ●

It is an excellent alternative to "heavy" (physically and optically) concrete pavement slabs, concrete openwork panels, paving stones, asphalt and other types of paved surfaces. The product is nature friendly, water permeable and almost invisible after sowing the grass. Recommended for intense traffic parks. Provides UV stabilization that prevents degradation by sunlight. Our products meet the requirements in accordance with PN-EN 124 and PN - EN1433. Product in load class A15 and B125



driveways



parking spaces



carports



storage areas



garden paths



wheelchair access paths



fire access routes

index [black / green]	dimensions [mm]	pcs./pallet	pallet height [cm]	material	connection
24564 / 24571	590 x 395 x 30	128	120 (stackable)	PE/PP	Interlocking male and female lugs
24588 (set - 4 pcs.)	590 x 395 x 120	32 sets	120 (stackable)	PE/PP	Interlocking male and female lugs

# Lawn Grid Plate 38 mm

Available colours: ● ●

The lawn grid plate 38 mm is designed to reinforce the surface in an environmentally friendly manner and does not interfere with the nature and physical features of the terrain. The Gardeco lawn grid plate is made of plastic. Self-locking hooks attached to the sides make the assembly of grates easy and fast. There are 4.2 lawn grid plate per 1 m<sup>2</sup>. The Gardeco lawn grid plate is an excellent alternative to concrete and asphalt coatings, as being better suited to extensive green areas, driveways, access roads, parking areas, slopes and pavements.

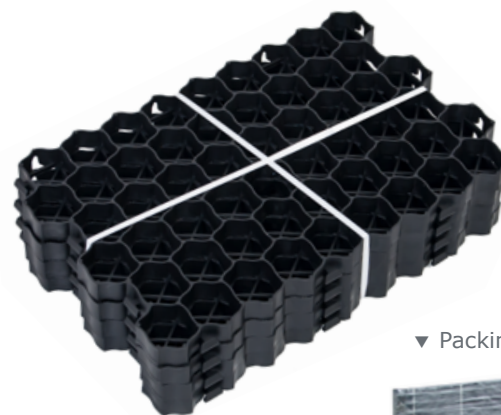

▼ Packing (4 pcs~1m<sup>2</sup>)



index [black / green]	dimensions [mm]	pcs. / pallet	pallet height [mm]	material	connection
23765 / 23758	590 x 395 x 38	112	1200 (stackable)	PE/PP	Interlocking male and female lugs
23161 (set - 4 pcs.)	590 x 395 x 152	28	1200 (stackable)	PE/PP	Interlocking male and female lugs



# DRAINAGE CHANNEL

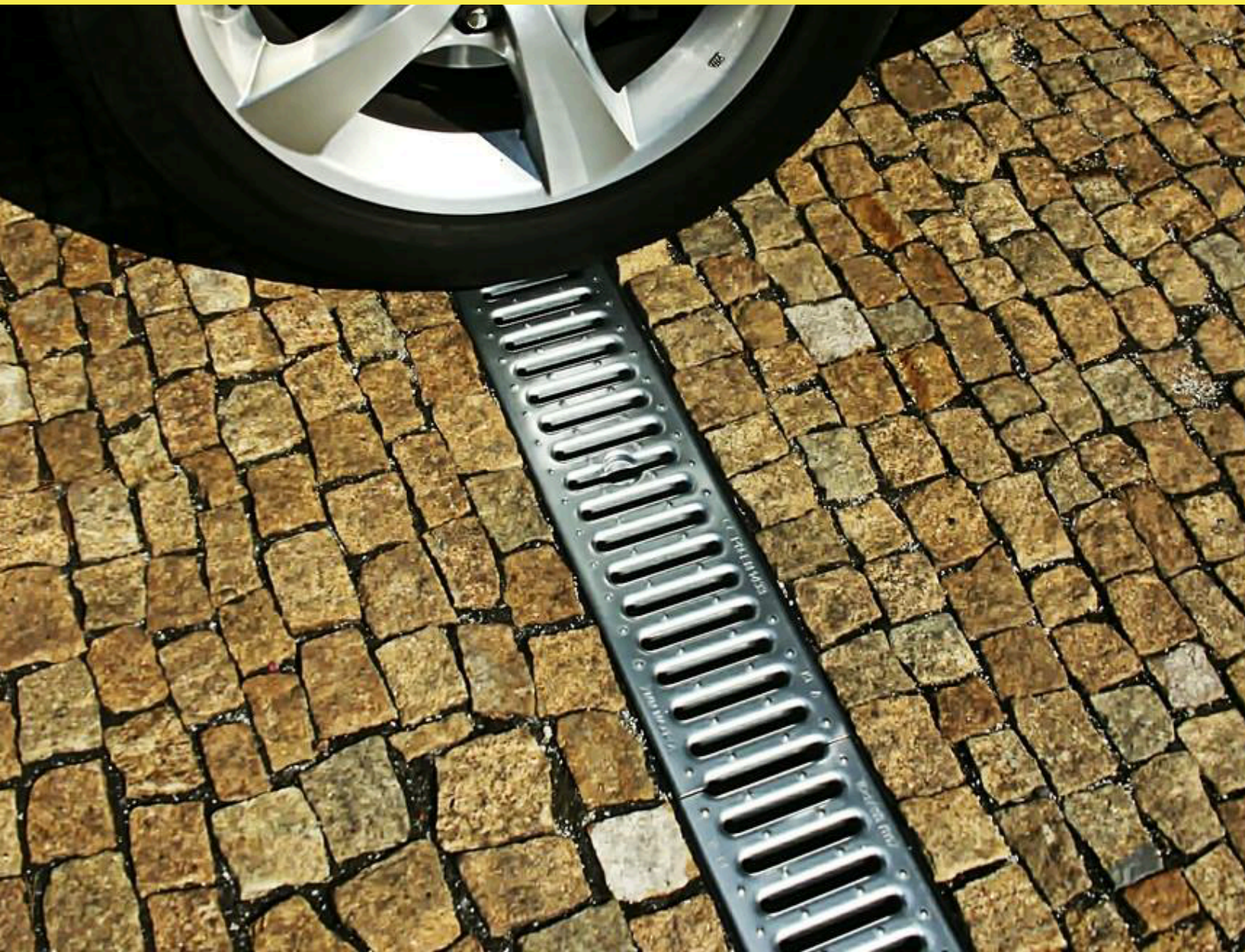

**EXTREMELY DURABLE, RESISTANT TO  
MECHANICAL DAMAGE, DOESN'T  
CORRODE AND IS EASY TO ASSEMBLE.**

---

Load class from A15 to C250.  
The offer includes comprehensive  
solutions for construction.

# Metal Channel Drainage



The Gardeco drainage channel is useful for draining water from sidewalks, squares, roads, garages, sports facilities, etc. It is the ideal option for those who truly value simple, comfortable and sustainable solutions. The linear drainage module consists of a 1000 x 130 x 98 mm channel and a metal grille. Unlike to drainage systems offered by competitors, our system has the capability to both lateral and bottom water removal. The use of polypropylene as a channel material guarantees a high chemical resistance including acids, alkalis, salts and organic solvents. Channel in A15 class for the most-chosen product in our offer.



patios and conservatories



garden and water features



walkways



pedestrian areas



garage thresholds



retaining walls

index	dimensions [mm]	pcs. / pallet	pallet height [mm]	grid
1738	1000 x 130 x 98	102	1850	metal

# Plastic Channel Drainage



Easy and quick to install unique variable outlet position. This product characterised by easily cut to desired length, safe and secure bar locking no need for corner unit A15 load rating - tested to EN 1433. The linear drainage module consists of a 1000x130x98 mm channel and a plastic grille. It is the ideal option for those who truly value simple, comfortable and sustainable solutions. The material PP / PE of which they are made makes them aesthetic and lightweight, which facilitates assembly and transport.

index	dimensions [mm]	pcs. / pallet	pallet height [mm]	grid
1718	1000 x 130 x 98	102	1850	plastic

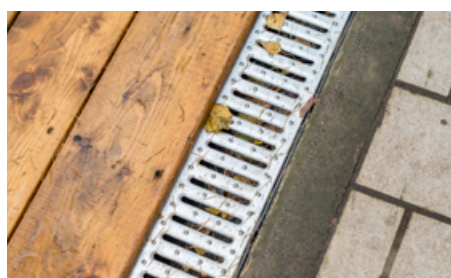

# Channel Drainage - Packing

Well engineered, high strength residential drainage system. Gardeco pack is designed to contain everything needed to install a typical domestic drainage system.



▼ Set contains

3x

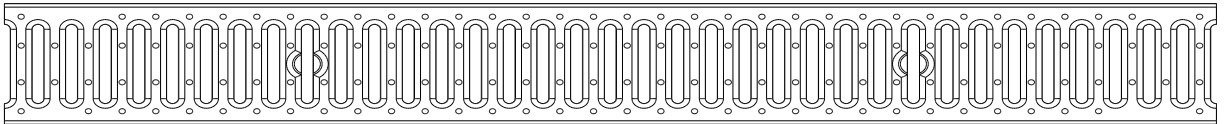

3x

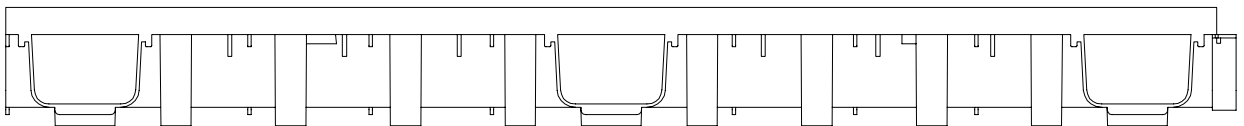

1x

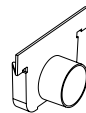

1x



6x

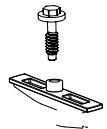

- 3 x 1m polipropylene channel unit
- 1 x end cap (Ø 50mm)
- 1 x outlet connector (Ø 110 mm or Ø 100 mm)
- 6 x mounting kit

index	articles in set	carton dimensions [mm]	pcs. / pallet	pallet height [mm]
M2684	1738 (or 1718) - 3 pcs. 1744 - 1 pcs. 1819 - 1 pcs.	1085 x 135 x 300	48 sets	2550

# Channel Drainage - Montage

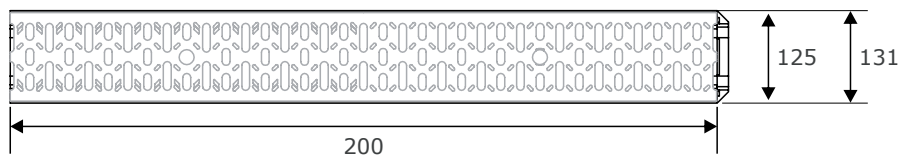
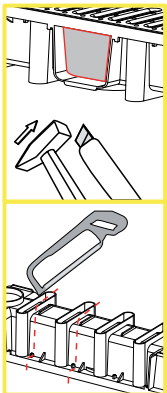
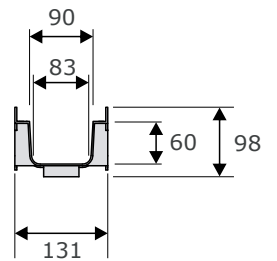
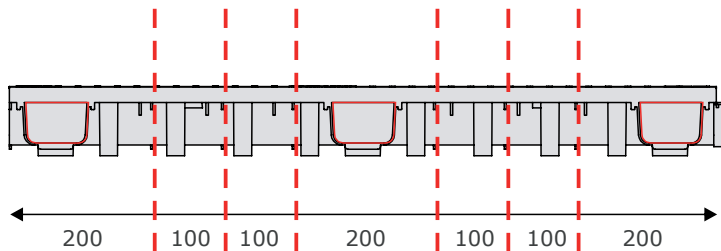
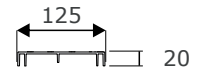
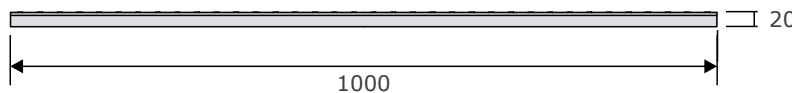
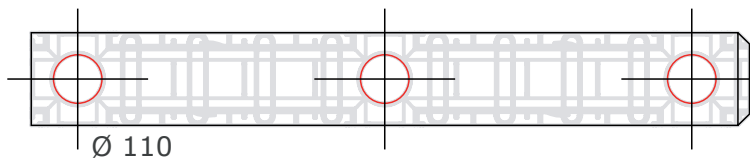
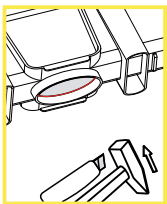
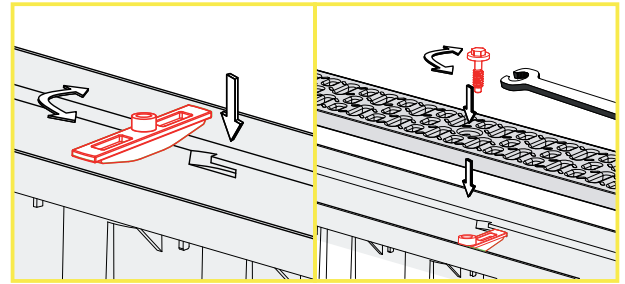
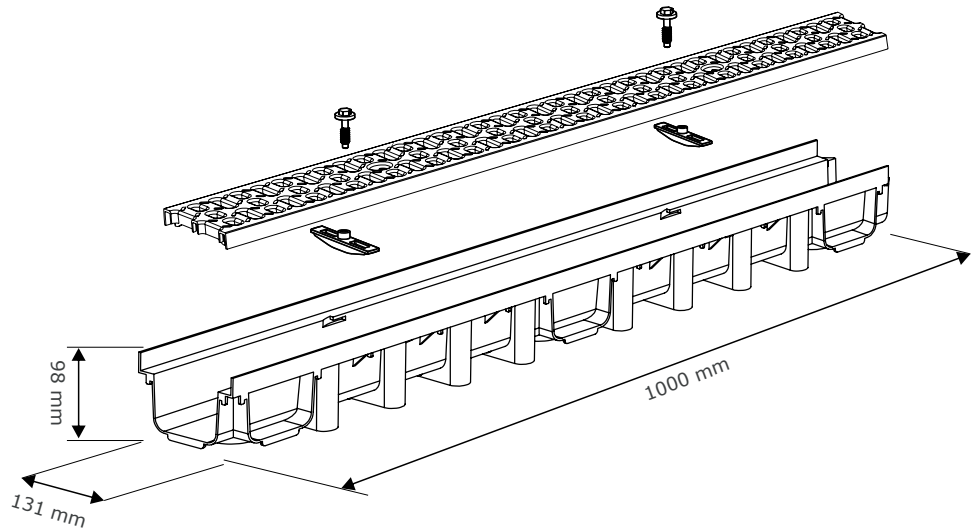
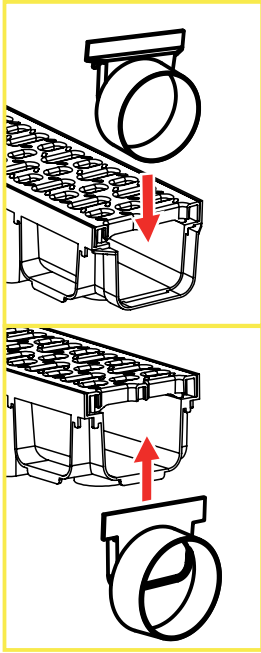



# Storm Drainage Channel



STORM drainage channel is ideally suited to your household as well as in the city. Channel design is strong and robust. It can be used on the driveway, in front of the garage, in the garden, on the patio, as well as on the bicycle roads or on the busy streets in the city center. Channel bore improves speed of water flow and promotes self cleansing. Environmentally friendly product is manufactured from recycled polypropylene and 100% recyclable. It is high quality channel fully certified to EN 1433. Load Class A 15. Channels clip together easily. Lightweight design is simple and fast to install. Grid is available in metal and plastic.



patios and conservatories



garden and water features



walkways



pedestrian areas



garage thresholds



retaining walls

index [black / green]	dimensions [mm]	pcs./pallet	pallet height [cm]	material	connection
24564 / 24571	590 x 395 x 30	128	120 (stackable)	PE/PP	Interlocking male and female lugs
24588 (set - 4 pcs.)	590 x 395 x 120	32 sets	120 (stackable)	PE/PP	Interlocking male and female lugs

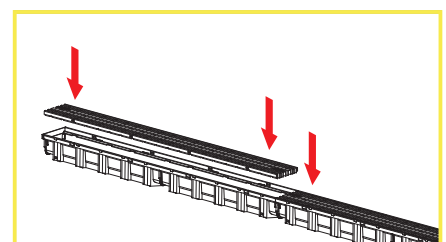
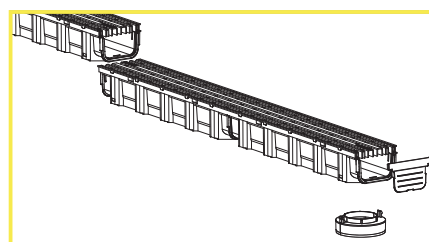
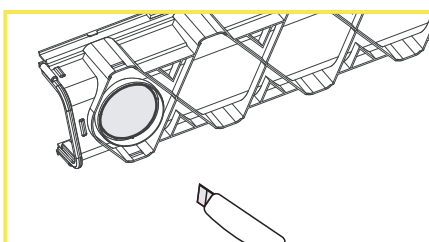
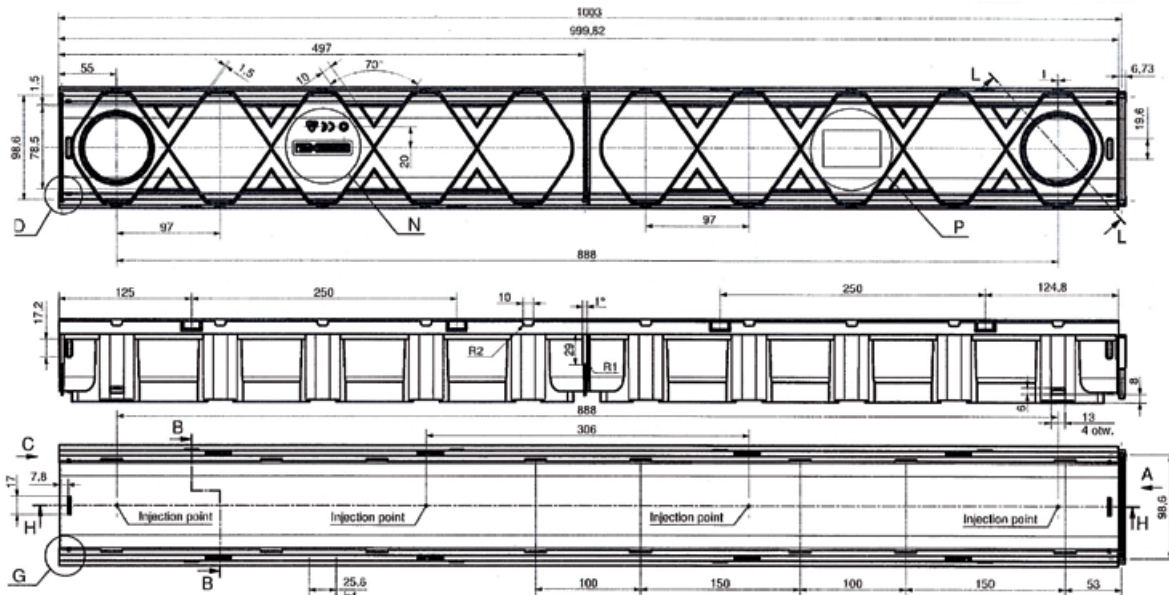

# LAWN BORDER



## THE LAWN EDGE IS INTENDED FOR THE AESTHETIC FINISHING OFF OF VARIOUS TYPES OF SURFACES.

---

The lawn border preventing grass overgrowth and separating the lawn from the rebates or cultivated part of the garden. With the help of Gardeco edges, you can designate and limit any shape of gravel or grit paths, e.g. for pedestrians, bicycles in parks and green areas.

# Lawn Border

The lawn border was made of plastic. It is 1000 mm long and 80 mm wide. It has holes that plastic anchors included in the set. It perfectly separates the lawn from pavement spilled with stone or the surface around sprinkled with bark, which will make the



pavement clinker and blocks



lawn



paving gravel and grit



garden bark



index	dimensions [mm]	pcs./display	pcs./pallet	displays/pallet	display dimensions [mm]	pallet height [mm]
01915	1000 x 80 x 45	50	300	6	1200 x 40 x 38	1200
23710	1000 x 80 x 70	30	180	6	1200 x 40 x 38	1200

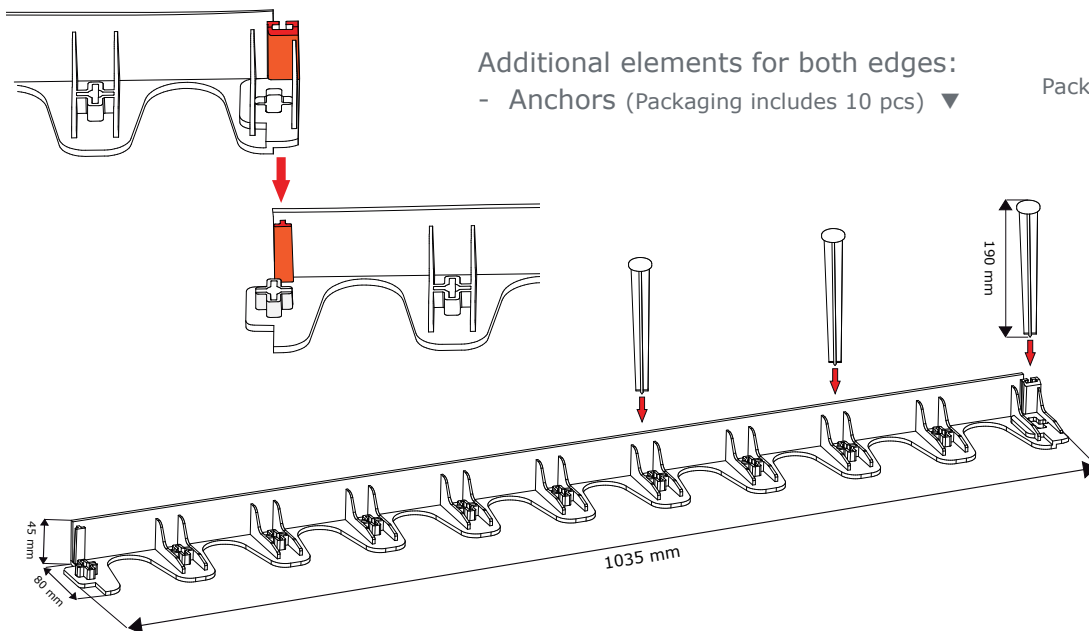

Additional elements for both edges:

- Anchors (Packaging includes 10 pcs) ▼

Packing ▶

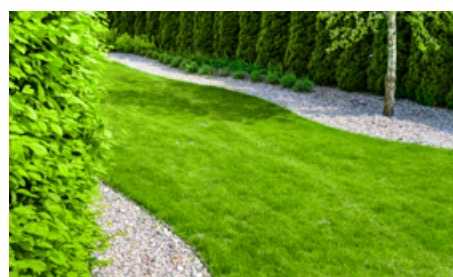
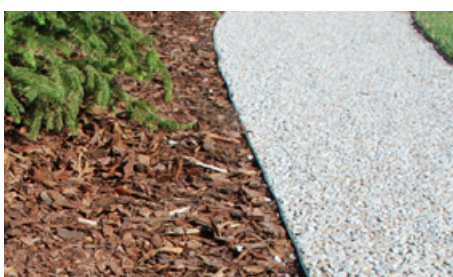

# GARDEN FENCE



## WE OFFER STYLISH FENCES FOR GARDEN LOVERS.

---

High quality, frost and UV resistant, flexibility - are some of the many other advantages that our products have. We invite you to familiarize yourself with the offer

# Classic Garden Fence

Available colours: ●



This product is made of high quality plastic and at the same time have the appearance of a metal product. Thus is virtually maintenance free, long lasting and cost next to nothing. Assembly of simple or irregular fences, separations of pavements, lawns, rock gardens and flower beds is done with ease, thankfully to its uncomplicated design. Tool free assembly. It is 3.1 metre long, when assembled out of 5 elements. UV-resistant, do not discolour.



garden paths



lawn



garden bark



decorative stone



flower bed

index	dimensions [mm]	pcs. / set	sets / carton	sets / pallet	pallet height [mm]
24908	620 x 300	5	10	80	80

# Garden border

Available colours: ● ● ● ●



Designed to separate flowerbeds, garden pathways and other surfaces poured with e.g. bark chippings, ornamental stones. It is a decorative element for every garden. Its major advantage is its elasticity, which allows for forming lines, curves or circles. The elements can be mutually connected, which makes it possible to create arrangements of any length. The height of the garden border is 116 mm, the width is 593 mm. It is made of polymer (PP material), thus it is very resistant to weather conditions. The fencing is easy to install, it should be just put into a pre-cut hole in the ground.

Packing ►

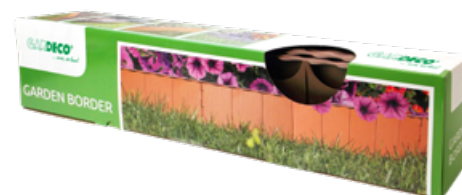

index	pcs. / display	display dimensions [mm]	display / pallet	pallet [mm]
25332	120	600 x 400 x 25	28	120 x 80 x 195



# CONTACT US



## **Lidia SAWICKA**

**Customer Service Manager**

Mail: [ls@gardeco.com.pl](mailto:ls@gardeco.com.pl)

Mobile: +48 665 914 665

Languages: polish, english

## **Weronika GLANOWSKA**

**Export Manager**

Mail: [verkauf@gardeco.com.pl](mailto:verkauf@gardeco.com.pl)

Mobile: +48 667 041 667

Languages: polish, english, german

---

### **Gardeco sp. z o.o.**

Torowa 3 B, 30-435 Cracow, Poland

tel: +48 12 295 08 20

[www.gardeco.com.pl](http://www.gardeco.com.pl)

[marketing@gardeco.com.pl](mailto:marketing@gardeco.com.pl)

[facebook.com/gardeco.krakow](https://facebook.com/gardeco.krakow)

[linkedin.com/company/gardecospzoo](https://linkedin.com/company/gardecospzoo)

**GARDECOCO<sup>®</sup>**  
**FOR LANDSCAPING**